

**CONTINENTAL**  
Store Fixture Group

*Product Guide*

Toll Free: 800.663.4674



Toll Free: 800.663.4674



# CONTINENTAL

## Store Fixture Group

International Gondola

### Continental Gondola

Multi functional, easily adjustable shelving system in both wall and island applications.

- A: UPRIGHT POST
- B: BACK PANELS
- C: RAILS (Top, Center, Bottom)
- D: BASE BRACKETS
- E: BASE FRONT
- F: BASE DECKS
- G: UPRIGHT POST END TRIM
- H: BASE END TRIM
- I: SHELF

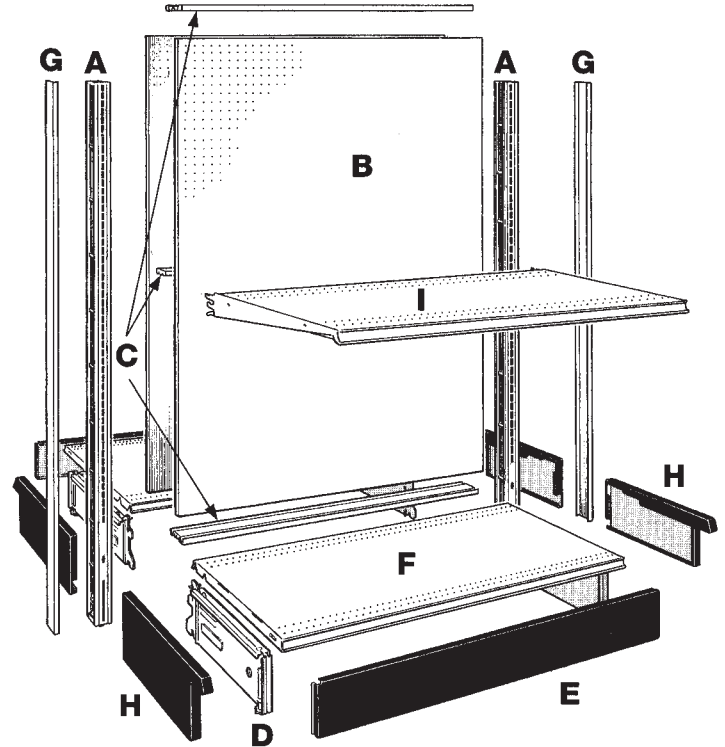

### For Add Ons

For add ons, you will not require parts as listed:

- 1-A Upright Post
- 2-G Upright Post End Trim
- 2-D Base Brackets
- 1 Pair-H Base End Trim

### POST HEIGHT AND CENTER RAIL LOCATIONS WITH BACK PANELS

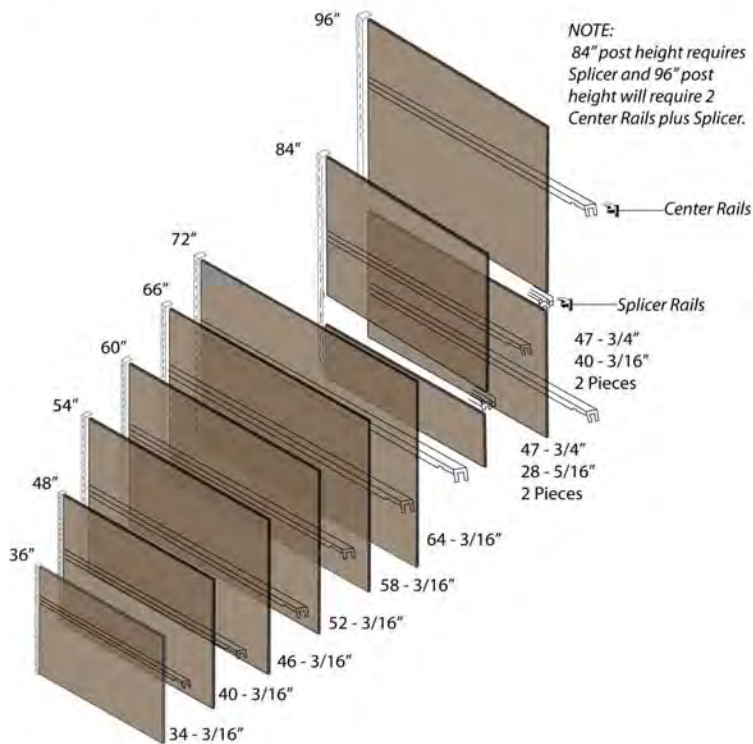



### Free Standing Wall End Displays

Pegboard front and back panels  
Uniformly distributed load of Deck  
600 lb. 13" 16" 19" and 22"  
Other back panel styles are available  
Order Shelves separately  
Order Gap Filler to close off bottom rear when the unit  
is wider than the island width  
Actual width of unit equals the nominal width plus 2"  
Base End Trim and Closed Base Front in Black Only

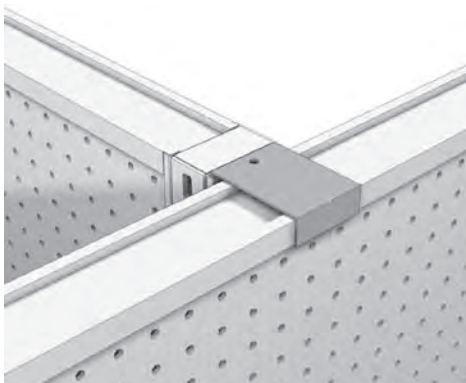

### Wall End Display Bracket

Attaches freestanding Wall End Display  
to same height or taller Gondolas  
Maintains End Display position  
Restricts movement from shopping carts or  
floor scrubbers

### No Base Wall End Display

Wall end display used without a Base Deck.  
Includes Upper and Lower Stabilizer  
(required to attach adjoining Island Section)  
Attaches to an equal height International Gondola Unit  
Includes Pegboard front and back panels  
Other panel styles are available  
Order rear gap filler separately when unit is wider than the island  
Order shelves separately  
Compatible with both 06 and low base



### NOTE:

All No Base Wall End Units intended for use with shelves, peg hooks, or slatwalls accessories must include a floor display to direct traffic away from protrusions. Extension Uprights can not be used on this display.

### Wall End Display Stabilizer

### Wall End Stabilizer with Base

Anchors Freestanding 30" 36" and 48"  
wall end display to a 36" or 48" Island Section  
Wall End and Gondola End Section Top Rail  
not required

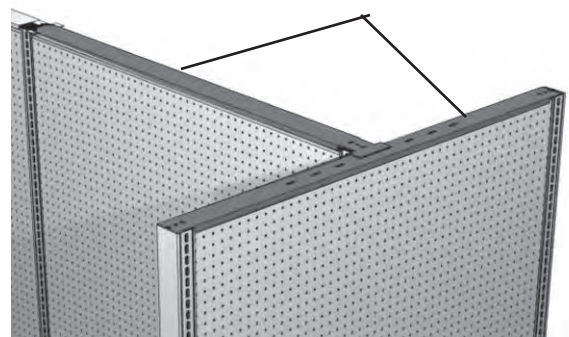



**Specialty Display**

**4 Way Display / Service and Display Counter Tops**



4 Way Gondola  
54" H 13" Deck  
48" Square w/ 12 - 13x36 inch Shelves

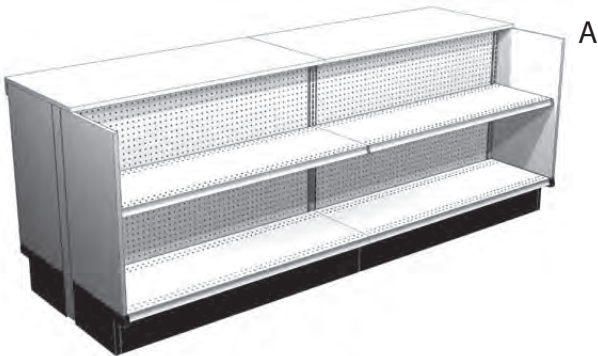

A



C



B

**Service and Display Counters**

A - Base deck 13" 16" 19"  
A- Counter Top 17" 20" 23"

B- Base Deck 13" -13" / 13" - 16" / 16"-16"  
B- Counter Top 32" 35" 38"

C- Base Deck 13"-13" / 13"-16" / 16"-16"  
C- Counter Top 30" 33" 36"

#### UPRIGHT POST

For Wall and Island sections, Slotted 1" on center  
Platinum, Silver Grey, White

##### PLATINUM

URP-36/P	36"	9.2 lb
URP-48/P	48"	11.8 lb
URP-54/P	54"	12.9 lb
URP-60/P	60"	14.2 lb
URP-66/P	66"	15.9 lb
URP-72/P	72"	17.2 lb
URP-84/P	84"	19.7 lb
URP-96/P	96"	22.5 lb

##### SILVER GREY

URP-36/G	36"	9.2 lb
URP-48/G	48"	11.8 lb
URP-54/G	54"	12.9 lb
URP-60/G	60"	14.2 lb
URP-66/G	66"	15.9 lb
URP-72/G	72"	17.2 lb
URP-84/G	84"	19.7 lb
URP-96/G	96"	22.5 lb

##### WHITE

URP-36/W	36"	9.2 lb
URP-48/W	48"	11.8 lb
URP-54/W	54"	12.9 lb
URP-60/W	60"	14.2 lb
URP-66/W	66"	15.9 lb
URP-72/W	72"	17.2 lb
URP-84/W	84"	19.7 lb
URP-96/W	96"	22.5 lb

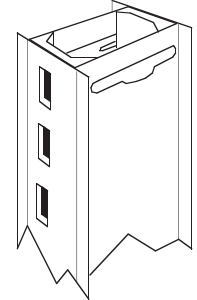

#### UPRIGHT POST END TRIM

Use to finish off end of section. Fits easily onto upright Platinum, Silver/Grey, or White finish.

##### PLATINUM

URPC-36/P	36"	.6 lb
URPC-48/P	48"	.8 lb
URPC-54/P	54"	.9 lb
URPC-60/P	60"	1.0 lb
URPC-66/P	66"	1.2 lb
URPC-72/P	72"	1.3 lb
URPC-84/P	84"	1.4 lb
URPC-96/P	96"	1.6 lb

##### SILVER GREY

URPC-36/G	36"	.6 lb
URPC-48/G	48"	.8 lb
URPC-54/G	54"	.9 lb
URPC-60/G	60"	1.0 lb
URPC-66/G	66"	1.2 lb
URPC-72/G	72"	1.3 lb
URPC-84/G	84"	1.4 lb
URPC-96/G	96"	1.6 lb

##### WHITE

URPC-36/W	36"	.6 lb
URPC-48/W	48"	.8 lb
URPC-54/W	54"	.9 lb
URPC-60/W	60"	1.0 lb
URPC-66/W	66"	1.2 lb
URPC-72/W	72"	1.3 lb
URPC-84/W	84"	1.4 lb
URPC-96/W	96"	1.6 lb

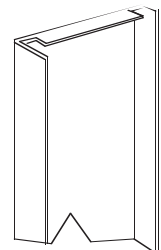

#### POST CAPS

Use to finish off end of section. Fits easily onto upright Platinum, Silver Grey, or White finish.

URPCAP/P	0.1 lb
URPCAP/G	0.1 lb
URPCAP/W	0.1 lb

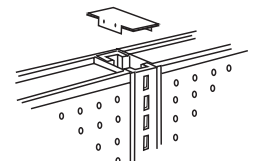



# CONTINENTAL

## Store Fixture Group

International Gondola

### WALL MOUNT STANDARDS

Wall mount standards are available in Platinum, Silver Grey or White finish.

WMST - 96 96"



### GONDOLA BASE DECK

Mounts on base bracket to create bottom shelf. Front molding accommodates 1-1/4" tags. Platinum, Silver Grey or White finish.

#### Platinum

BD 3013 / P	13" x 30"	7.0 lb
BD 313 / P	13" x 36"	8.6 lb
BD 316 / P	16" x 36"	9.5 lb
BD 319 / P	19" x 36"	10.7 lb
BD 322 / P	22" x 36"	12.3 lb
BD 413 / P	13" x 48"	11.9 lb
BD 416 / P	16" x 48"	12.9 lb
BD 419 / P	19" x 48"	14.2 lb
BD 422 / P	22" x 48"	16.9 lb

#### Silver Grey

BD 3013 / G	13" x 30"	7.0 lb
BD 313 / G	13" x 36"	8.6 lb
BD 316 / G	16" x 36"	9.5 lb
BD 319 / G	19" x 36"	10.7 lb
BD 322 / G	22" x 36"	12.3 lb
BD 413 / G	13" x 48"	11.9 lb
BD 416 / G	16" x 48"	12.9 lb
BD 419 / G	19" x 48"	14.2 lb
BD 422 / G	22" x 48"	16.9 lb

#### White

BD 3013 / W	13" x 30"	7.0 lb
BD 313 / W	13" x 36"	8.6 lb
BD 316 / W	16" x 36"	9.5 lb
BD 319 / W	19" x 36"	10.7 lb
BD 322 / W	22" x 36"	12.3 lb
BD 413 / W	13" x 48"	11.9 lb
BD 416 / W	16" x 48"	12.9 lb
BD 419 / W	19" x 48"	14.2 lb
BD 422 / W	22" x 48"	16.9 lb

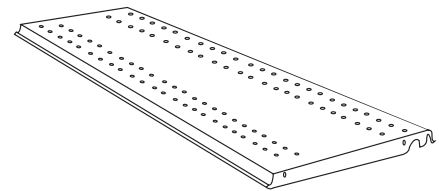

### BASE BRACKET

Includes a leveling leg for uneven floors.

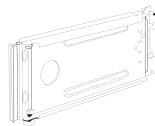

BBS-06-13 / B	13" Deck / Actual Length 10" Bracket	1.9 lb
BBS-06-16 / B	16" Deck / Actual Length 13" Bracket	2.3 lb
BBS-06-19 / B	19" Deck / Actual Length 16" Bracket	2.7 lb
BBS-06-22 / B	22" Deck / Actual Length 19" Bracket	3.1 lb

### BASE FRONT

Closed, finished appearance. Black finish.

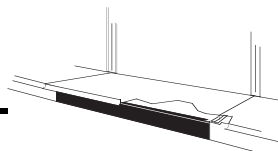

FKP-06-30 / B	30" x 6" Deck	2.2 lb
FKP-06-36 / B	36" x 6" Deck	3.2 lb
FKP-06-48 / B	48" x 6" Deck	4.2 lb

### BASE END TRIM

Attaches to edge of base bracket for clean finish. Black finish. Sold in pairs.

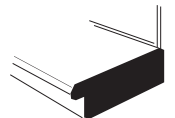

BSC-06-13 / B	13" Long	3.4 lb
BSC-06-16 / B	16" Long	3.8 lb
BSC-06-19 / B	19" Long	4.7 lb
BSC-06-22 / B	22" Long	5.7 lb



### TOP RAIL

Finishes and supports top of panel.  
Platinum, Silver Grey and White.

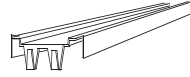

#### Platinum

TR-30 P	30"	1.0 lb
TR-36 P	36"	1.4 lb
TR-48 P	48"	1.8 lb

#### Silver Grey

TR-30 G	30"	1.0 lb
TR-36 G	36"	1.4 lb
TR-48 G	48"	1.8 lb

#### White

TR-30 W	30"	1.0 lb
TR-36 W	36"	1.4 lb
TR-48 W	48"	1.8 lb

### SPLICER RAIL

Splices two panels together.  
Platinum, Silver Grey and White.

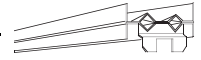

#### Platinum

SP-30 P	30"	1.0 lb
SP-36 P	36"	1.7 lb
SP-48 P	48"	2.4 lb

#### Silver Grey

SP-30 G	30"	1.0 lb
SP-36 G	36"	1.7 lb
SP-48 G	48"	2.4 lb

#### White

SP-30 W	30"	1.0 lb
SP-36 W	36"	1.7 lb
SP-48 W	48"	2.4 lb

### CENTER RAIL

Spaces and supports uprights.  
Paint Finish

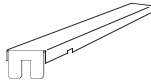

CR-30	30"	1.0 lb
CR-36	36"	1.2 lb
CR-48	48"	1.4 lb

### SLATWALL CENTER RAIL

Spaces and supports uprights of slatwall.  
Paint Finish



SWCR-30	30"	1.6 lb
SWCR-36	36"	2.1 lb
SWCR-48	48"	2.8 lb

### BOTTOM RAIL

Supports bottom of panel.  
Platinum, Silver/Grey and White.

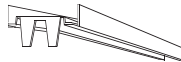

#### Platinum

LR-30 P	30"	0.6 lb
LR-36 P	36"	1.1 lb
LR-48 P	48"	1.5 lb

#### Silver Grey

LR-30 G	30"	0.6 lb
LR-36 G	36"	1.1 lb
LR-48 G	48"	1.5 lb

#### White

LR-30 W	30"	0.6 lb
LR-36 W	36"	1.1 lb
LR-48 W	48"	1.5 lb

### SLATWALL HEAVY DUTY BOTTOM RAIL

Reinforced to support Slatwall weight.  
Platinum, Silver Grey and White.

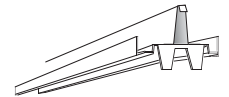

#### Platinum

SWLR-30 P	30"	2.0 lb
SWLR-36 P	36"	2.6 lb
SWLR-48 P	48"	3.3 lb

#### Silver Grey

SWLR-30 G	30"	2.0 lb
SWLR-36 G	36"	2.6 lb
SWLR-48 G	48"	3.3 lb

#### White

SWLR-30 W	30"	2.0 lb
SWLR-36 W	36"	2.6 lb
SWLR-48 W	48"	3.3 lb



# CONTINENTAL

## Store Fixture Group

International Gondola

### PEG BOARD

1/4" diameter hole.  
1" on center spacing with equal margins.  
Available in Platinum, Silver Grey and White.

### Peg Board Sizes

P-3648	34 3/16" x 46 1/2"	12.6 lb.
P-4848	40 3/16" x 46 1/2"	14.3 lb.
P-5448	46 3/16" x 46 1/2"	17.1 lb.
P-6048	52 3/16" x 46 1/2"	19.3 lb.
P-6648	58 3/16" x 46 1/2"	21.4 lb.
P-7248	64 3/16" x 46 1/2"	23.5 lb.
P-8448 (2 pce)	47 3/4" x 46 1/2"	17.1 lb.
P-8448 B	28 5/16" x 46 1/2"	10.5 lb.
P-9648 (2 pce)	47 3/4" x 46 1/2"	17.1 lb.
P-9648 B	40 3/16" x 46 1/2"	15.0 lb.
P-3636	34 3/16" x 34 1/2"	10.0 lb.
P-4836	40 3/16" x 34 1/2"	10.5 lb.
P-5436	46 3/16" x 34 1/2"	12.6 lb.
P-6036	52 3/16" x 34 1/2"	15.9 lb.
P-6636	58 3/16" x 34 1/2"	19.3 lb.
P-7236	64 3/16" x 34 1/2"	19.3 lb.
P-8436 (2 pce)	47 3/4" x 34 1/2"	12.6 lb.
P-8436 B	28 5/16" x 34 1/2"	9.5 lb.
P-9636 (2 pce)	47 3/4" x 34 1/2"	12.6 lb.
P-9636 B	40 3/16" x 34 1/2"	10.0 lb.
P-5430	46 3/16" x 28 1/2"	9.0 lb.
P-7230	64 3/16" x 28 1/2"	17.0 lb.

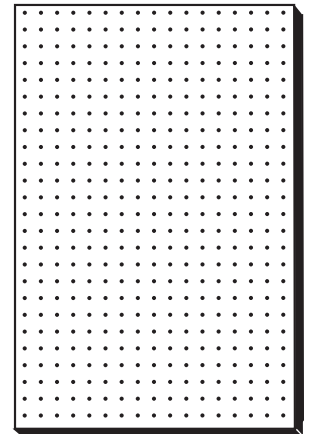

### MARTEK SOLID BOARD

Stock sizes available in Platinum, Silver Grey and White. Other sizes available upon special order.

M-5436	54" x 36"
M-5448	54" x 48"



### SLATWALL

Stock colors are Almond, Silver Grey, White, and Hard Rock Maple.  
Custom finishes available upon request.  
Slatwall Panels for Gondolas, please refer to peg board sizes.

SW-4896	48" x 96"
---------	-----------

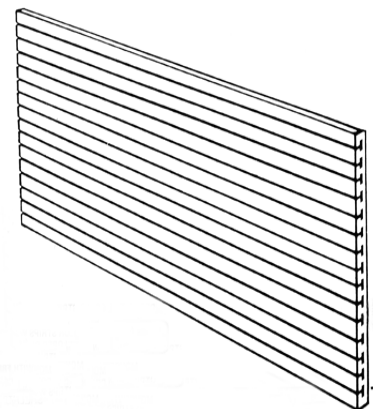

### CENTER SHELF

Front molding accomodates 1-1/4" tags.  
Platinum, Silver/Grey or White finish.

#### Platinum

DUS 1330 / P	30" x 13"	6.6 lb
DUS 310 / P	36" x 10"	6.6 lb
DUS 313 / P	36" x 13"	8.0 lb
DUS 315 / P	36" x 15"	8.7 lb
DUS 317 / P	36" x 17"	10.7 lb
DUS 319 / P	36" x 19"	11.6 lb
DUS 322 / P	36" x 22"	12.5 lb
DUS 410 / P	48" x 10"	9.7 lb
DUS 413 / P	48" x 13"	10.8 lb
DUS 415 / P	48" x 15"	11.7 lb
DUS 417 / P	48" x 17"	13.9 lb
DUS 419 / P	48" x 19"	14.8 lb
DUS 422 / P	48" x 22"	19.1 lb

#### Silver/Grey

DUS 1330 / SG	30" x 13"	6.6 lb
DUS 313 / SG	36" x 13"	8.0 lb
DUS 316 / SG	36" x 16"	10.1 lb
DUS 319 / SG	36" x 19"	11.6 lb
DUS 322 / SG	36" x 22"	15.3 lb
DUS 413 / SG	48" x 13"	10.8 lb
DUS 416 / SG	48" x 16"	12.6 lb
DUS 419 / SG	48" x 19"	14.8 lb
DUS 422 / SG	48" x 22"	19.1 lb

#### White

DUS 1330 / W	30" x 13"	6.6 lb
DUS 310 / W	36" x 10"	6.6 lb
DUS 313 / W	36" x 13"	8.0 lb
DUS 315 / W	36" x 15"	8.7 lb
DUS 319 / W	36" x 19"	11.6 lb
DUS 322 / W	36" x 22"	15.3 lb
DUS 410 / W	48" x 10"	9.7 lb
DUS 413 / W	48" x 13"	10.8 lb
DUS 415 / W	48" x 15"	11.7 lb
DUS 417 / W	48" x 17"	13.9 lb
DUS 419 / W	48" x 19"	14.8 lb
DUS 422 / W	48" x 22"	19.1 lb

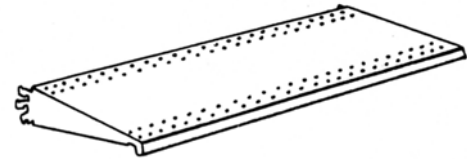

#### CENTER SHELF FEATURES

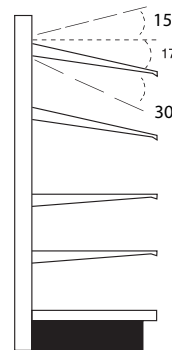

SHELVES HAVE 4 WAY ADJUSTABLE BRACKET FOR VARIOUS MERCHANDISE REQUIREMENTS.

#### Load Capacity:

15 degree Up Slope: 300 lb.  
17 degree Down Slope: 250 lb.  
30 degree Down Slope: 125 lb.  
Standard Flat Position: 500 lb.



# CONTINENTAL

## Store Fixture Group

International Gondola

### INTERLOCKING WIRE FENCING

Heavy duty steel construction suitable for bulky items. Available in 3" and 5" in heights. Easy snap in installation that interlocks. Chrome finish.

#### Wire Front

348 - BF	3" x 48"	1.2 lb
548 - BF	5" x 48"	2.0 lb

#### Wire Divider

516-BFD	5" x 16"	0.5 lb
522-BFD	5" x 22"	0.8 lb

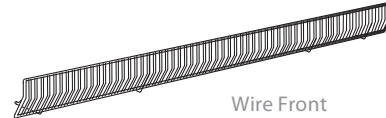
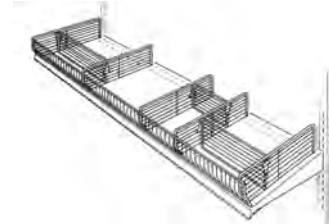

Wire Front

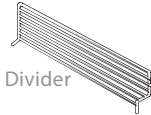

Wire Divider

### FREESTANDING WIRE FENCING Chrome Finish

#### Wire Front

WF - 330	3" x 30"	0.6 lb
WF - 336	3" x 36"	0.8 lb
WF - 348	3" x 48"	1.0 lb

#### Wire Divider

WFD - 310	3" x 10"	0.3 lb
WFD - 313	3" x 13"	0.4 lb
WFD - 315	3" x 15"	0.6 lb
WFD - 317	3" x 17"	0.8 lb
WFD - 319	3" x 19"	1.0 lb

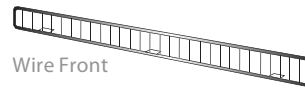

Wire Front

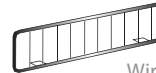

Wire Divider



### WIRE BASKETS 3" front / 6" back Chrome Finish

#### Wire Baskets

WB-1436	14" x 36"	6.0 lb
WB-1448	14" x 48"	6.7 lb

#### Wire Divider

WBD - 14	6" x 14"	0.5 lb
----------	----------	--------

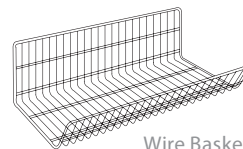

Wire Basket



Wire Basket Divider

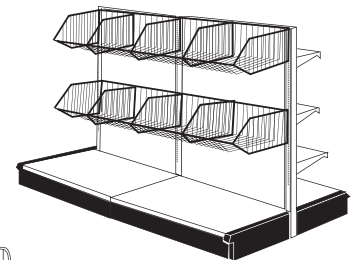

### Endless Wire Shelves 3" front / 3" back Chrome Finish

WS-1448	14" x 48"	7.8 lb
---------	-----------	--------

#### Wire Shelf Dividers

WSD - 14 (wire divider)	3" x 14"	0.3 lb
WCD - 4 (cross divider)	3" x 4"	0.1 lb

#### Wire Bracket

WBBKT 15 / Pairs	0.5 lb
------------------	--------

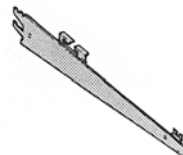

Wire Basket Bracket

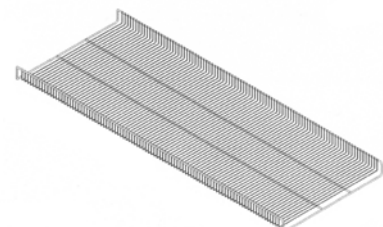

Wire Divider



Cross Divider

ALL WIRE FLIP SCAN HOOKS

Flip Scan Hooks

---

FSAWM4	4"
FSAWM6	6"
FSAWM8	8"
FSAWM11	11"

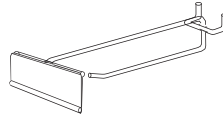

Flip Scan Labels

---

FSLH30-0051	2" x 1-1/4"
FSLH30-0064	2.5" x 1-1/4"
FSLH30-0076	3" x 1-1/4"



ALL WIRE PEG HOOKS

---

Light Duty Peghook

---

LB-2	2"
LB-4	4"
LB-6	6"
LB-8	8"



Medium Duty Peghook

---

MB-4	4"
MB-6	6"
MB-8	8"
MB-10	10"



Heavy Duty Peghook

---

HB-4	4"
HB-6	6"
HB-8	8"
HB-10	10"
HB-12	12"



Plastic Back Peghook

---

PBMB - 8	8"
PBHB - 10	10"





# CONTINENTAL

## Store Fixture Group

Multi Retail Shelving

### MRS Starter System

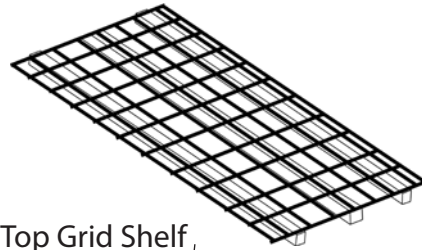

Top Grid Shelf

MRS Shelves have ticket molding on both sides.

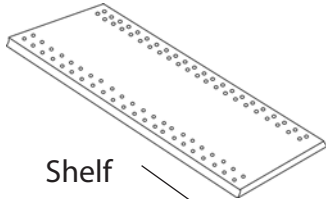

Shelf

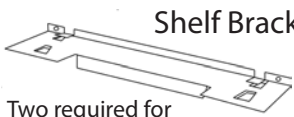
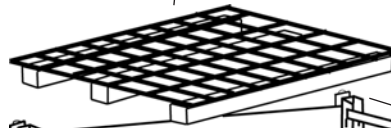

Shelf Bracket

Two required for each shelf and grid shelf.



Peg Board and Slatwall Channel

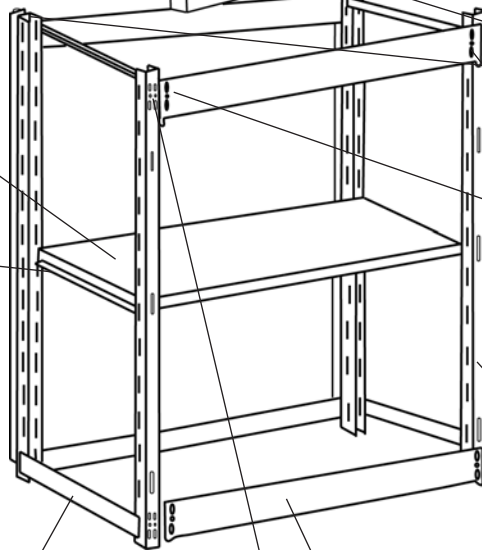

Safety Pins (all cross beams)



Cross Brace

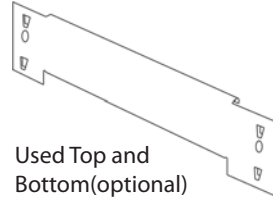

Used Top and Bottom (optional)

Cross Beam

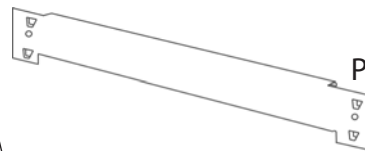

Please note that the Cross Beams and Cross Braces Insert into the punched holes on the Posts as shown.

Post



### UPRIGHT POST

For Mac Rack Shelving System  
 Available in Stock color Grey  
 Special Order Clearcoat, Gun Metal and  
 other paint colors available

MURP-35	35"
MURP-38	38"
MURP-60	60"
MURP-84	84"
MURP-96	96"
MURP-120	120"



### MRS PEG BOARD and SLATWALL CHANNEL

MPC-84	84" MRS PEG / SLATWALL CHANNEL
MPC-96	96" MRS PEG / SLATWALL CHANNEL
MPC-120	120" MRS PEG / SLATWALL CHANNEL

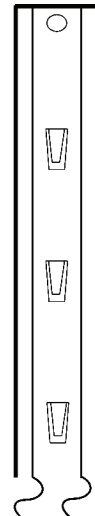
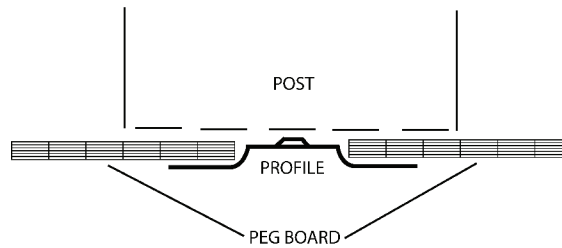

### CROSS BEAM

For Mac Rack Shelving System  
 Available in Stock color Grey  
 Special Order Clearcoat, Gun Metal and  
 other paint colors available

---

MCB-24	24"
MCB-36	36"
MCB-48	48"

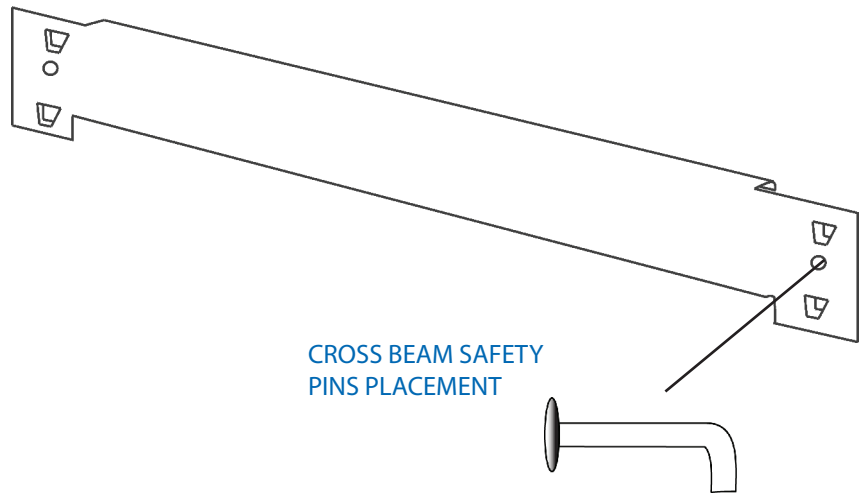

### SIDE CROSS BEAMS (optional)

SCB-16	16"
SCB-22	22"
SCB-24	24"

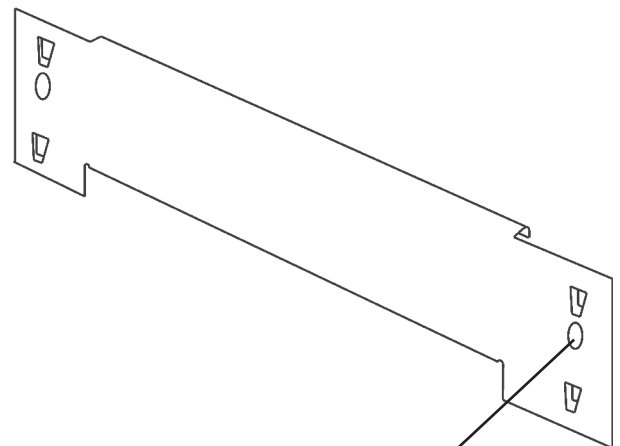

For Extra Support use a nut  
 and bolt. (optional)



**SHELVES**

For Mac Rack Shelving System  
 Available in Stock color Grey  
 Special Order Clearcoat, Gun Metal and  
 other paint colors available

---

MUS-1624	16" x 24"
MUS-1636	16" x 36"
MUS-1648	16" x 48"
MUS-2224	22" x 24"
MUS-2236	22" x 36"
MUS-2248	22" x 48"
MUS-2436	24" x 36"
MUS-2448	24" x 48"

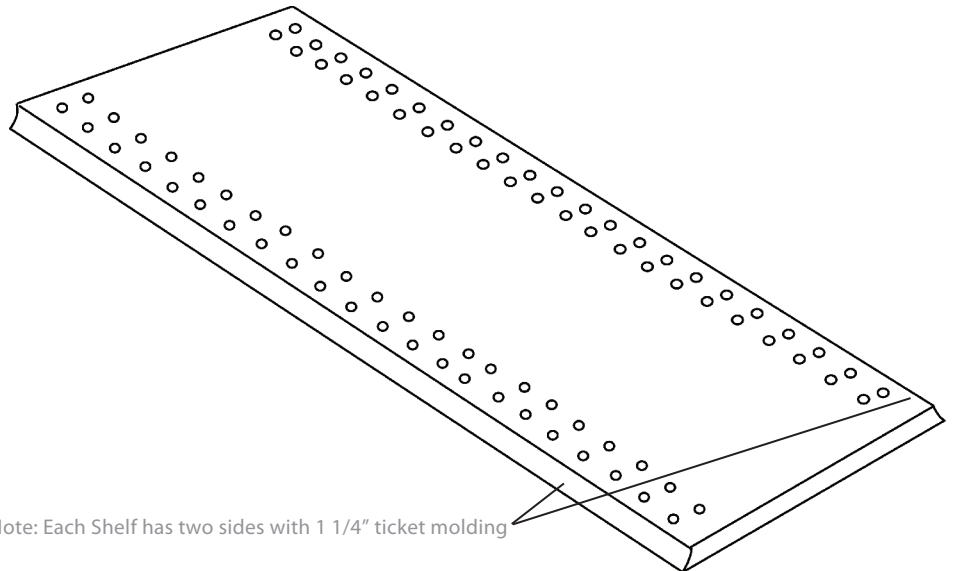

Note: Each Shelf has two sides with 1 1/4" ticket molding

**SHELF BRACKETS**

Note: Each Shelf requires two brackets.

SS-216	16" Shelf Bracket
SS-316	16" Shelf Bracket
SS-416	16" Shelf Bracket
SS-222	22" Shelf Bracket
SS-322	22" Shelf Bracket
SS-422	22" Shelf Bracket
SS-324	24" Shelf Bracket
SS-424	24" Shelf Bracket

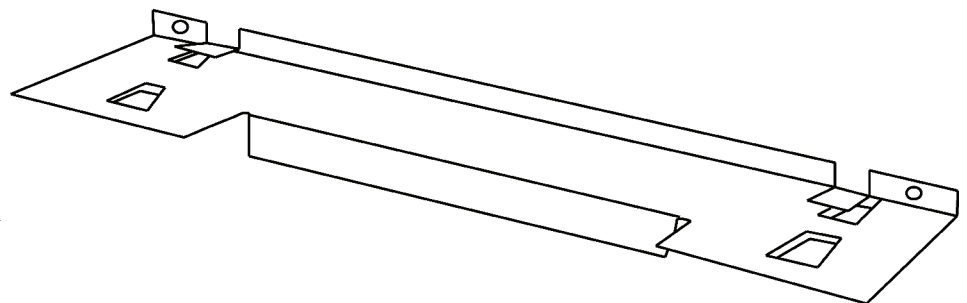



# CONTINENTAL

## Store Fixture Group

Multi Retail Shelving

### WIRE TOP SHELVES

For Mac Rack Shelving System  
Available in Stock color Grey  
Special Order Clearcoat, Gun Metal and  
other paint colors available

---

MUSW-1624	16" x 24"
MUSW-1633	16" x 36"
MUSW-1645	16" x 48"
MUSW-2224	22" x 24"
MUSW-2233	22" x 36"
MUSW-2245	22" x 48"
MUSW-2445	24" x 48"

Note: Shelf sizes may be smaller than noted  
in order to fit correctly.

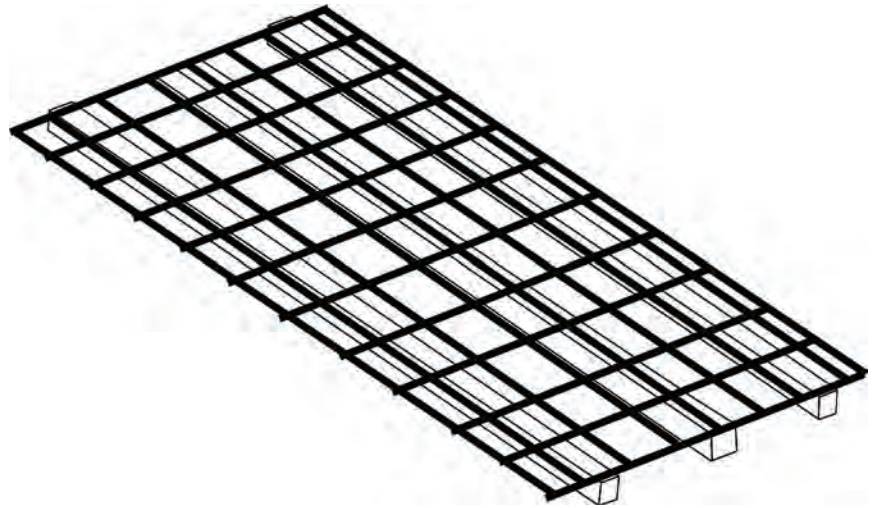

### TOP SHELF BRACKETS

Note: Each Shelf requires two brackets.

SS-16	16" Shelf Bracket
SS-22	22" Shelf Bracket
SS-24	24" Shelf Bracket

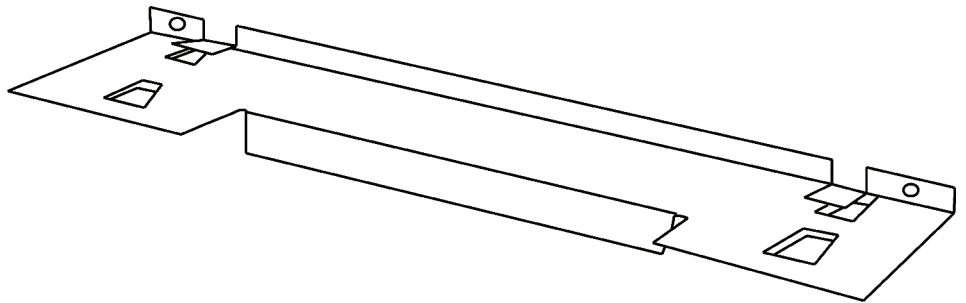



#### MRS ACCESSORIES

For Mac Rack Shelving System  
Available in Stock color Grey  
Special Order Clearcoat, Gun Metal and  
other paint colors available

#### MRS BAR

M-BAR-4 4 ft. Bar

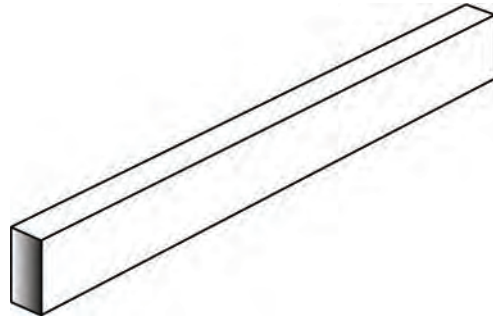

#### MRS BAR BRACKET

Two Required for Each Bar

M-BAR-BRKT

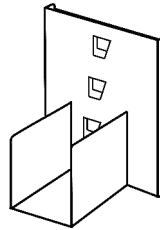

#### MAC BAR

M-1048 10" x 48" Mac Bar

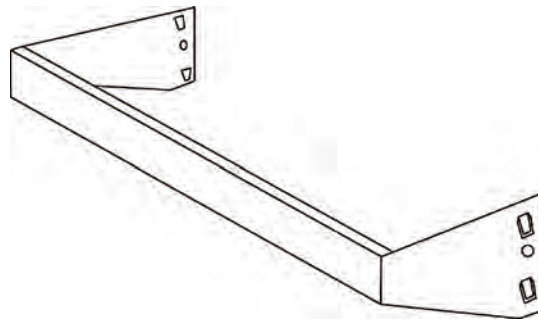

#### ADJUSTABLE FRAME BRACKETS

Note: 4 Brackets are required for each frame.

M-BRK-ADJ-16 16"  
M-BRK-ADJ-22 22"  
M-BRK-ADJ-24 24"

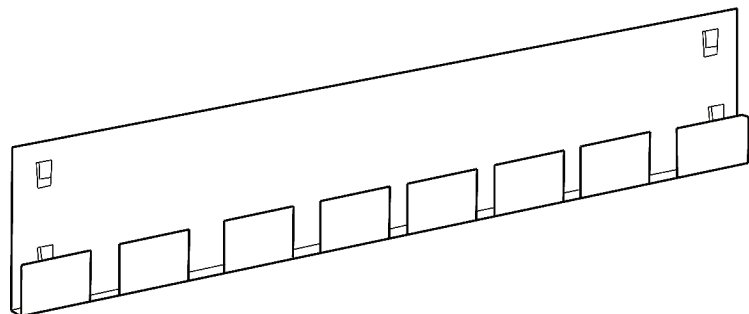

### MRS ACCESSORIES

For Mac Rack Shelving System  
 Available in Stock color Grey  
 Special Order Clearcoat, Gun Metal and  
 other paint colors available

### ADJUSTABLE FRAMES

Note: 4 Brackets are required for each frame.

MF 1248	12" x 48"
MF 2436	24" x 36"
MF 2448	24" x 48"

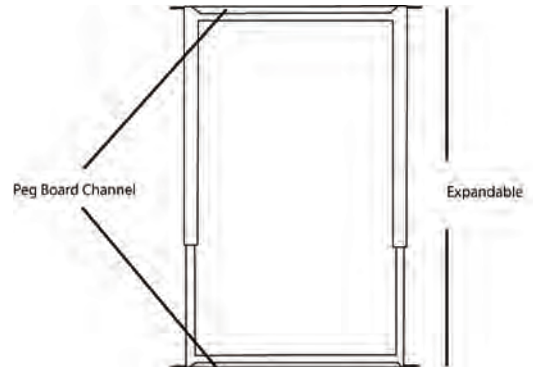

### PEG BOARD

P-8222	22" x 82"
P-8234	34 3/4" x 82"
P-8246	46 3/4" x 82"

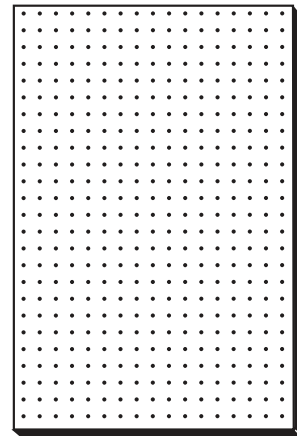

### SLATWALL

MF-1248	12" x 48"
MF-2436	24" x 36"
MF-2448	24" x 48"

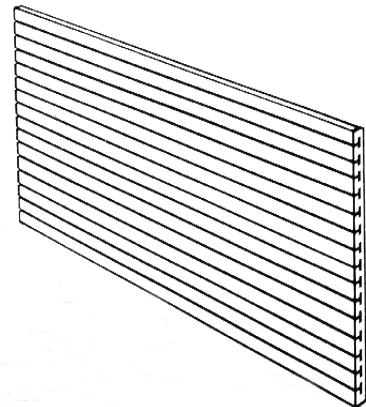

### MRS ACCESSORIES

For Mac Rack Shelving System  
 Available in Stock color Grey  
 Special Order Clearcoat, Gun Metal and  
 other paint colors available

### WIRE SLATGRID

SG37/G	3' x 7'
SG47/G	4' x 7'
GW2/B	Connecting Clips for Slatgrid (not shown)

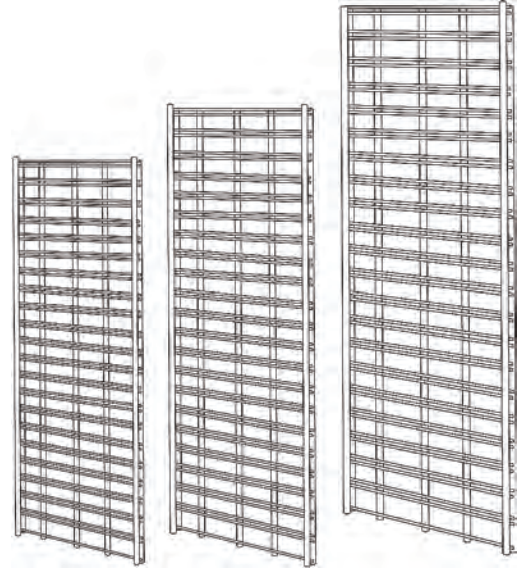

### 15 DEGREE SLOPING BRACKETS

MBKT-SS-22-SL/R	22" Right
MBRKT-SS-22-SL/L	22" Left

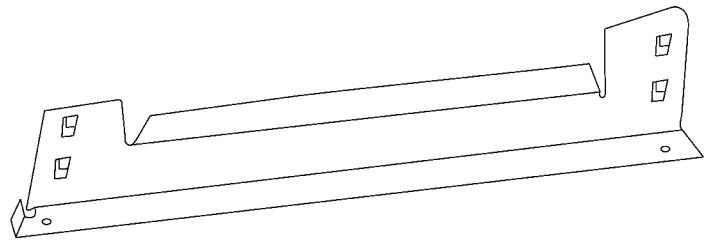

### WIRE BASKETS

MR-WB12	12" back and 6" front
MR-WB06-22	6" back and 3" front
SS-22	Two 22" Shelf Brackets are required per Basket (not shown)

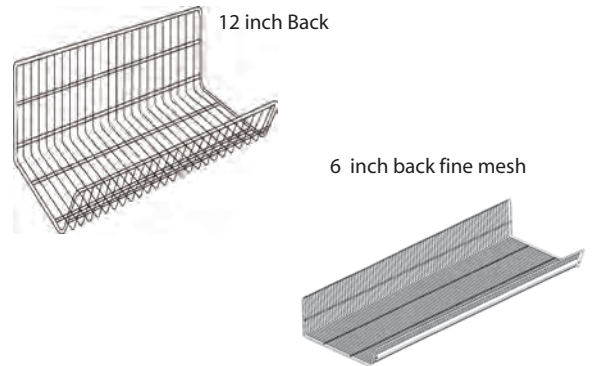

### WIRE DIVIDERS

MR-WBD12	22" Wire Basket Divider
MR-WBD0622	22" Wire Basket Divider for small wire basket

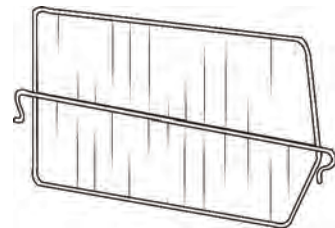

#### MRS ACCESSORIES

#### WIRE FENCE

345BF 3" x 45" Front Fence Chrome

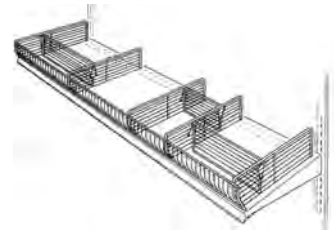

#### FRONT FENCE DIVIDERS

516BDF 5" x 16" Front Fence Dividers Chrome  
 522BDF 5" x 22" Front Fence Dividers Chrome  
 524BDF 5" x 24" Front Fence Dividers Chrome

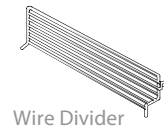
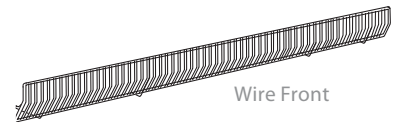

#### MAC RACK HOOKS

Note: This Item is Used in Conjunction with the Mac Bars.

M-Hook-16 16" w/ support and ball  
 M-Hook-22 22" w/ support and ball

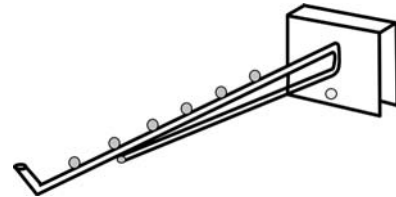

#### SCANNER HOOKS

6-SH 6" Scanner Hooks w/ 2" Metal front  
 8-SH 8" Scanner Hooks w/ 2" Metal front  
 10-SH 10" Scanner Hooks w/ 2" Metal front

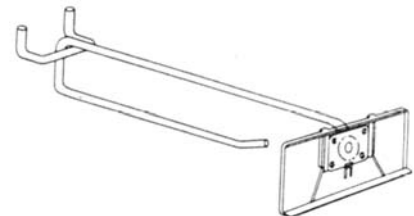

#### GRID WALL SCANNER HOOKS

GWH4-SCG 4" Scanner Hooks w/ 2" Metal front  
 GWH8-SCG 8" Scanner Hooks w/ 2" Metal front

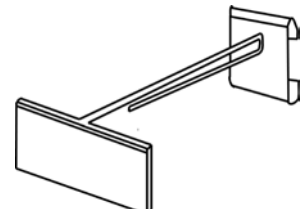

# Specialty Display

# Rolls Goods Display

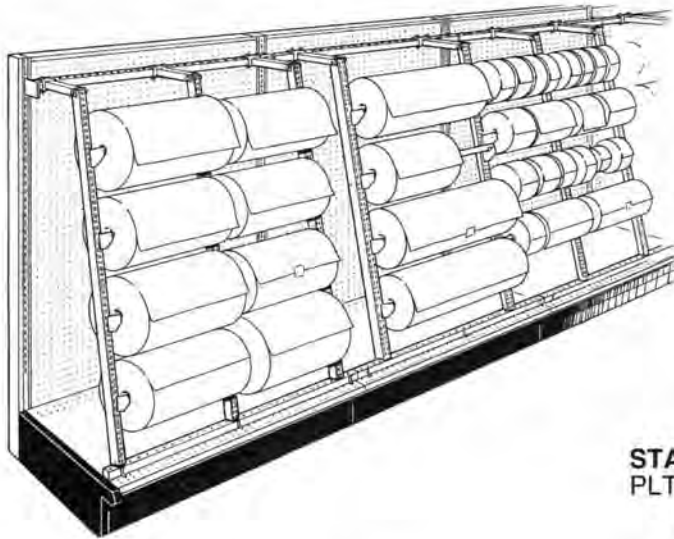

Roll Goods Displayer can be used to display and dispense various sizes and types of roll goods including screening, shading films, and vinyl runners. Uprites can be spaced closer together for heavier loads such as chain and wire.

Uprite arm projects from 10" to 13" away from the shelving back panel to fit 16" through 22" deep base decks. Uprites are available to fit to the top of 54" and 72" 06 base shelving heights.

Order (1) Support Assembly for each 4' shelving section and the desired number of Uprite & Hangrod Assemblies.

**Recommended capacity - 800 lbs. per 4' section.**

### STANDARD FINISH:

PLT (Platinum) Support Assembly, Uprite Assembly & Hangrod Brackets, Code A  
Optional Tier I colors **only**, Code B

**NOTE:** Hangrods are GLV (Galvanized) **only**.

### SUPPORT ASSEMBLY

(Consists of (1) each 48" wide Upper Support & Deck Support)

WIDTH	WT.	CAT. NO.	PLT EACH	TIER I EACH	CARTON <sup>①</sup>
48"	6.5				2

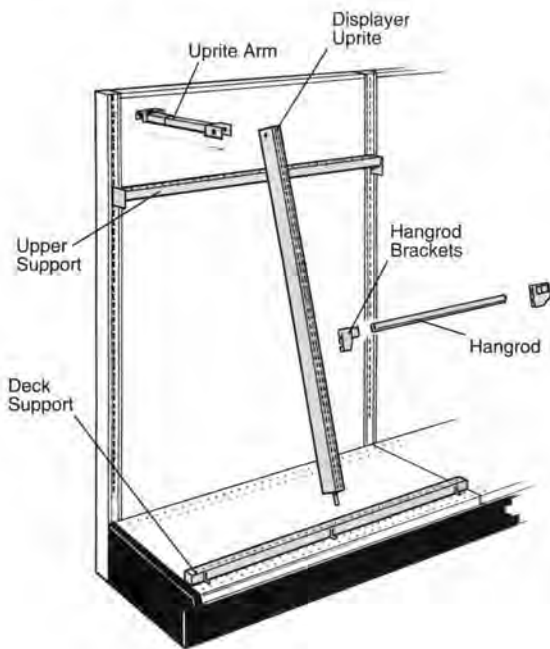

### UPRITE ASSEMBLY

(Consists of (1) each Displayer Uprite & Uprite Arm)

HT.	WT.	CAT. NO.	PLT EACH	TIER I EACH	CARTON <sup>①</sup>
54"	6.0				2
72"	7.0				2

<sup>①</sup> Available in carton package **only**. Orders will be rounded up to nearest carton quantity as listed above.

### HANGROD COMPONENTS

	WIDTH	WT.	CAT. NO.	FINISH	PLT PK4 <sup>②</sup>	TIER I PK4 <sup>②</sup>
Brackets (Pair)	—	1.0		PLT		
Hangrod	48"	18.0		GLV		N/A

<sup>②</sup> Available in packs of 4 only.

**Toll Free: 800.663.4674**



**BRITISH COLUMBIA**

Langley (604) 348-9182

**ALBERTA**

Edmonton (780) 453-2358  
Calgary (403) 250-7881  
Red Deer (403) 340-3599

**SASKATCHEWAN**

Saskatoon (306) 955-1430  
Regina (306) 514-3665