

e.z.rect® TYPE 1

THE HAND LOAD STORAGE SYSTEM
Using Interlocking Boltless Components
THE ORIGINAL BOLTLESS SYSTEM



GENERAL
Storage

e-z-rect® TYPE 1

This brochure illustrates the wide variety of uses for E-Z-Rect shelving in both commercial and industrial applications. Shelving is used in support of each material handling function associated with receiving, production, storage, order picking and for the retail sector - stockroom storage and merchandise display. E-Z-Rect also recognizes the increased concern for earthquake protection and is designed to be easily engineered to meet your local building code requirements.

Whether you're searching for shelving or answers to storage problems, let our experienced representatives or E-Z-Rect Distributors apply their expertise to suit your needs.

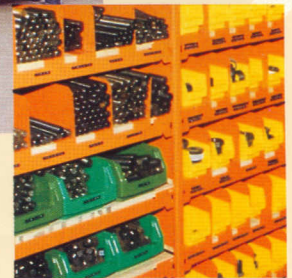

E-Z-Rect's versatile shelving system allows you to better organize and control inventories saving valuable floor and shelf space.

Our unique design is fully adjustable and accessible from both sides.

RECORD Storage



Archival and Record shelving is designed to accommodate any size carton or storage container providing for maximum storage density and easy access.



Our project design team is pleased to offer layout and engineering assistance to meet your specific requirements.

E-Z-Rect is suitable for manual or mechanically assisted mobile systems providing full use of floor space. Only one access aisle is required to service several rows of shelving.

Increase Productivity - High density storage provides maximum utilization of cubic area thereby increasing efficiency by reducing the distance travelled to perform the storage and retrieval functions.

**TWO-TIER
MULTI-LEVEL
Storage**

e-z-rect® TYPE 1

This high quality product is designed and engineered for strength and rigidity, yet versatile enough to meet your present and future storage needs. Our safety factor of 1.66 to 1 conforms to AISI standards.



E-Z-Rect mezzanine and catwalk systems offer an unobstructed second level for bulk storage or ready access to additional shelf storage....whatever your needs dictate. Decking or grating is supported by boltless, pre-formed mezzanine and aisle connectors making assembly simple. Shelving and decking can be easily disassembled and relocated, as required.

CATWALK SYSTEM

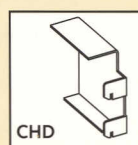
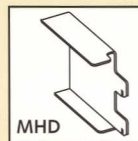
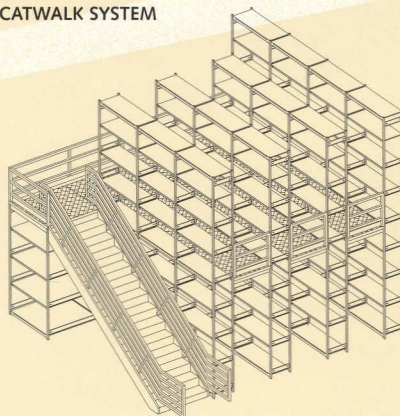

MEZZANINE SYSTEM

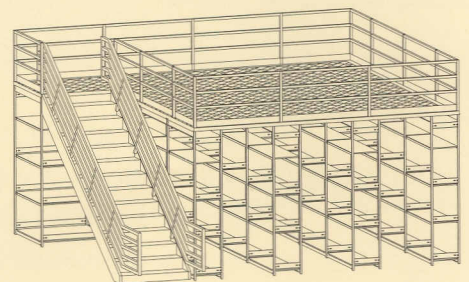

RETAIL Storage



Versatile, instant adjustability and attractive appearance combine to make E-Z-Rect an excellent choice for retail display. An additional benefit is the reduced cost when compared to typical store fixture designs.

Simple interlocking assembly without NUTS, BOLTS, or RIVETS ensures fast installations and big savings in time and labour cost. User friendly, no special tools or skilled tradespeople are required.



Shelves are fully adjustable on 2" centres giving the retailer the flexibility of change on demand. E-Z-Rect is so attractively finished, it can be used practically anywhere!

E-Z-Rect components are packaged in clear shrink-wrapped poly-film assuring a clean product every time. In addition, poly-film provides protection against weather and shipping damage.

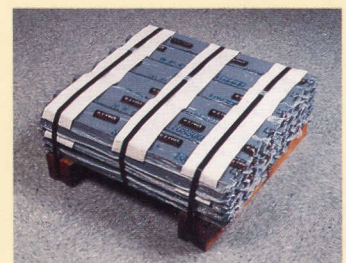

BOLTLESS
Connectors
and Supports

e-z-rect® TYPE 1

ONLY FOUR BASIC COMPONENTS

PB/PBL FRAME CONNECTOR

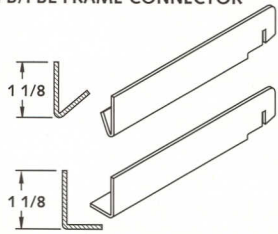

B FRAME CONNECTOR

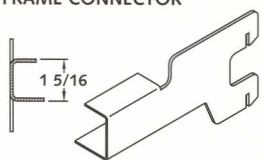

WB FRAME CONNECTOR

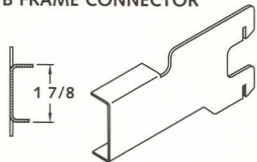

HD FRAME CONNECTOR

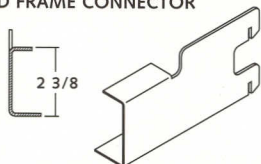

XHD FRAME CONNECTOR

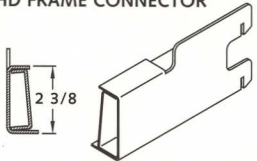

SHELF BAR OR GARMENT
ROD SUPPORT

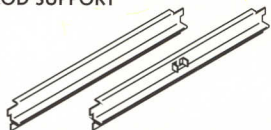

WT COMBINATION TIE
BAR/SHELF SUPPORT

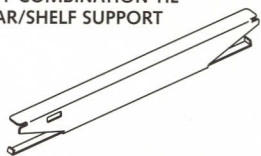

1. POST

2. POST CONNECTORS
(Connects 2 posts to make an END
FRAME.)

3. FRAME CONNECTORS

(Joins end frame together & supports
metal or particleboard shelf.)

4. SHELF

(Supports shelf load.)

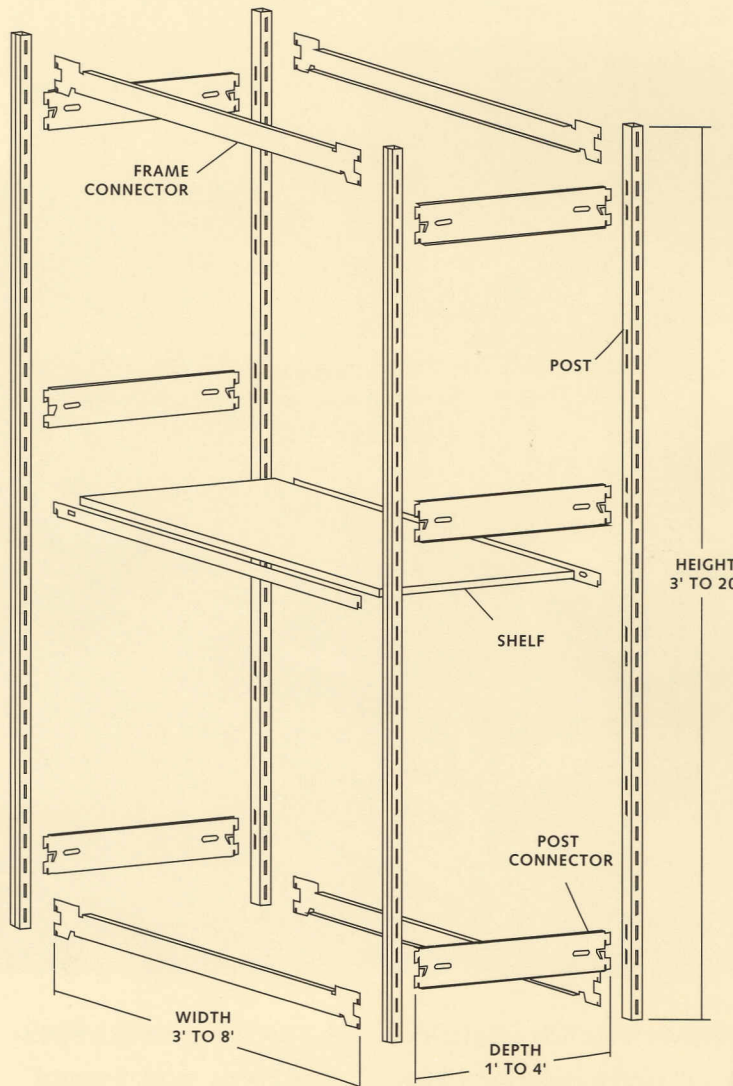

■ There's only 4 basic parts to assemble your shelving needs with a full range of accessories to suit any specific requirement.

■ Instant adjustment on 2" centres to desired shelf level. Attractively finished in standard grey electrostatic baking enamel. Special colours available upon request

■ E-Z-Rect's design allows for full use of shelf width. Therefore, when designing shelving layout allow the following for creepage to accommodate the outside frame dimensions.

■ 1 1/4" (32mm) for depth of unit.

■ 1 1/2" (38mm) for length of each frame used in a shelving run.

POST CONNECTOR

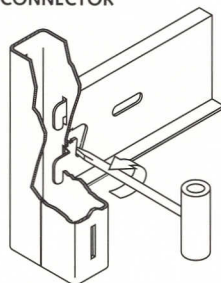

Features new easy to lock or unlock post connector. Use a common screwdriver or chainsaw wrench to twist locking tab.

PATENTED CONSTRUCTION
CDN 1991; USA 35082388;
EURO #0,572,477

ACCESSORIES
Work Bench
Sectional Shelves

**SECTIONAL SHELVES OFFERS YOU MORE STRENGTH
 AND LESS INVENTORY.**

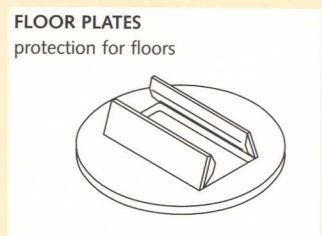
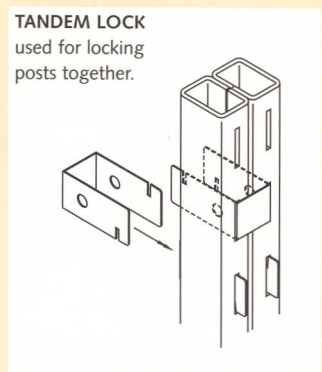
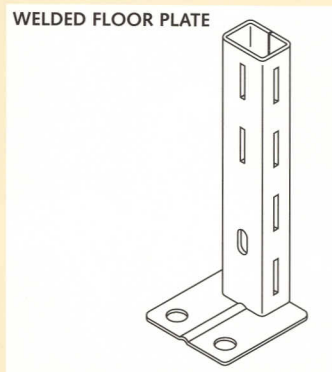
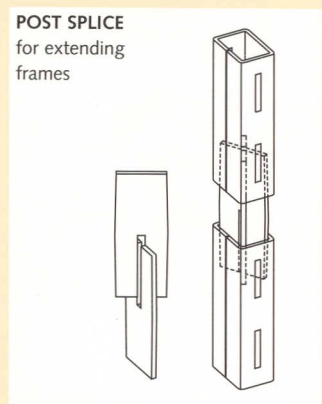
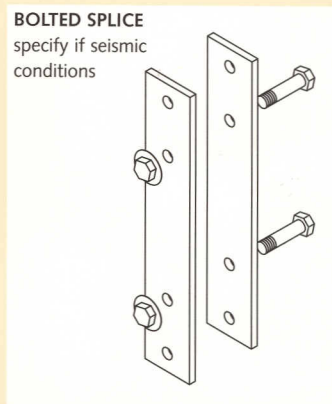
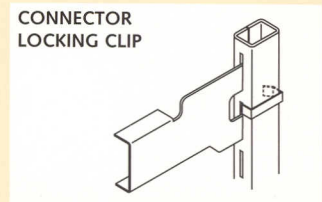
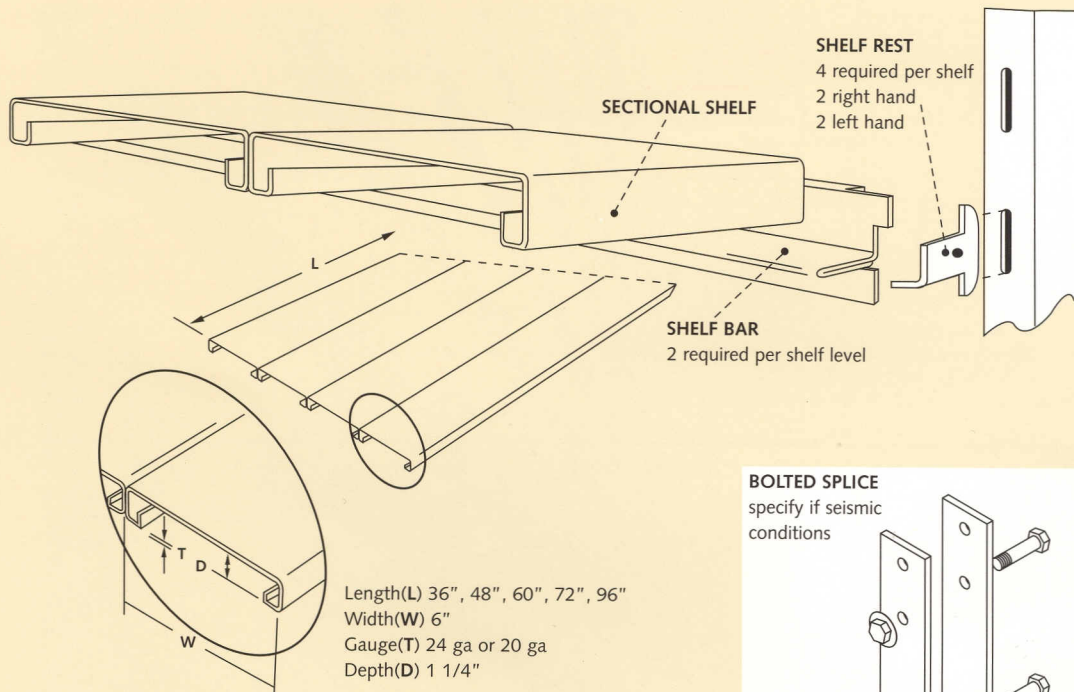

WORK BENCH, PACKING OR SHIPPING BENCH
 full range available



WORK BENCH 24"x48". Standard height. 48" add-on units available. Plywood not supplied. Use standard 4'x4' or 4'x8', cut 26" for top and 22" for shelf.
CASTERS (optional) for use with workbench as shown

LOAD CAPACITIES (IN LBS.) Maximum evenly distributed static load per pair of connectors

SHELF LENGTH	30"	36"	42"	48"	60"	66"	72"	96"
PB Frame Connectors	-	400	340	300	150	-	-	-
B Frame Connectors with L Tie & O Shelf Support	-	700 1400	620 1100	550 900	400 530	-	-	-
WB Frame Connectors with WT Combination Tie Bar & Shelf Support	-	1200 1800	1050 1640	950 1500	700 1200	575 1030	480 900	-
HD Frame Connectors with WT Combination Tie Bar & Shelf Support	-	1650 2000	1550 1950	1400 1900	1000 1700	900 1600	800 1500	450 900*
XHD Tube Frame Connectors with WT Combination Tie Bar & Shelf Support	-	-	-	-	-	-	-	-
	-	-	-	2400	2400	2400	2400	1700*

- Connectors are designed for an overall Safety Factor of 1.66 to 1 which conforms to AISI Standards. Deflection is limited to 1/140 for spans
* Two WT Combination Tie Bar and Shelf Supports must be used.

LOAD CAPACITIES (IN LBS.) Maximum evenly distributed static load per connector

MHD Mezzanine Heavy Duty	-	1500	-	1500	1200
MXD Mezzanine Extra Heavy Duty	-	1850	-	1850	1650
CHD Catwalk Heavy Duty	1500	1500	-	1500	1200

- Mezzanine and Catwalk connectors are designed for an overall Safety Factor of 1.66 to 1 which conforms to AISI Standards.
Deflection is limited to 1/180 for spans
- Loads stated above are for one connector.

LOAD CAPACITIES, METAL SHELF PANELS AND SECTIONAL SHELVES (IN LBS.) Maximum evenly distributed static load

METAL SHELF PANEL (LENGTH)	36"			48"			60"	
	24 ga	20ga	18 ga	24 ga	20ga	18 ga	24 ga	20 ga
12"-24" depth with C Shelf Rest	-	-	350	-	-	300	-	-
12"-36" depth with B Frame Connectors	-	-	600	-	-	500	-	-
12"-36" depth with B Frame Connectors Shelf Supports & Tie Bars	-	-	1200	-	-	800	-	-
SECTIONAL SHELF								
12" with Shelf Rest and Shelf Bars	300	400	-	200	300	-	180	270
18" with Shelf Rest and Shelf Bars	450	600	-	300	450	-	270	405
24" with Shelf Rest and Shelf Bars	600	800	-	400	600	-	360	540
30" with Shelf Rest and Shelf Bars	650	650	-	500	650	-	450	675
36" with Shelf Rest and Shelf Bars	575	575	-	575	575	-	540	575
48" with Shelf Rest and Shelf Bars	425	425	-	425	425	-	425	425

- Shelves are designed for an overall Safety Factor 1.66 to 1 which conforms to AISI Standard on shelves. Deflection is limited to 1/140 for spans.
- For heavier loads and longer lengths add frame connectors, tie bars and shelf supports using load capacities on first table.
- We recommend every company adopt a shelving safety and maintenance policy. For more information please contact E-ZRect Manufacturing Ltd.

Distributed by:

MANUFACTURED BY
E-Z-RECT MANUFACTURING LTD.
Manufacturers of Steel Shelving for Warehouses, Libraries and Offices

HEAD OFFICE
94 Riverside Drive, North Vancouver,
B.C. Canada V7H 2M6
TEL. (604) 929-5461
FAX (604) 929-5184

TORONTO
185 Admiral Blvd.,
Mississauga, Ontario L5T 2T3
TEL. (905) 564-0890
FAX (905) 564-0953

U.K.